

C1000



Owner's Manual

Use and Care
Troubleshooting
Warranty Information

Introduction	2
Overview.....	2
Components of lift system	3
Component List	4
Specifications	4
Cautions	6
Attaching the airline to the lift	7
Operation	
Turning the lift ON and Automatic OFF	8
Raising/Lowering the carry bar.....	9
Moving the lift along the track.....	9
Moving the "H" system traversing beam.....	10
Attaching the carry bar to the lift.....	11
Return to Charge	12
Basics in transferring an individual.....	13
C1000 Tandem Bariatric System.....	16
Charging the lift	18
Constant Charger	19
LCD Display Functionality	20
Emergency Stopping	22
Emergency Lowering.....	22
Emergency Manual Raising or Lowering.....	23
Cleaning and Disinfection.....	24
Trouble Shooting	25
General inspection and maintenance.....	26
Lift Accessories	27
Service record history.....	28
Warranty	32





CAUTION: DO NOT ATTEMPT TO USE THIS EQUIPMENT WITHOUT FIRST UNDERSTANDING THE CONTENTS OF THIS MANUAL.

Introduction

Before using this equipment, and to ensure the safe operation of your C1000 lift, carefully read this entire manual, especially the section on “Cautions”. The C1000 is designed to be used in conjunction with Handicare lift track, accessories and slings. Please refer to any user guides supplied with these components and refer to them while reviewing this manual.

Should any questions arise from reviewing this manual contact your local authorized Handicare dealer. Failure to comply with warnings in this manual may result in injury to either the operator, or the individual being lifted/transferred. Damage to the lift and/or related components may also occur. Be sure that the contents of this manual are completely understood prior to using this piece of equipment.

Store this manual with the documents included with the lift system and sling (s). Contents of this manual are subject to change without prior written notice.

Overview of C1000 lift system

The C1000 is a lifting aid used by health care professionals and those providing care in the home to lift, position and transfer clients or a disabled family member. The C1000 lift is part of what is termed ceiling lift technology which takes advantage of lifting from above and not from below or the side. Additionally the ceiling lift does not take up valuable floor space as most traditional methods do. Finally, the ceiling lift makes it possible to move mobility impaired individuals with minimal strain or risk to the caregiver, while providing complete safety, dignity and comfort for the client or family member.

The C1000 lift is one of three major components that make up this technology. The other two components are the track and sling. The C1000 lift runs on the lift track which is securely mounted to the ceiling structure of the institution, or home with the use of ceiling brackets. The track itself is made of specially designed aluminum and comes in many different shapes, lengths and configurations, and is custom tailored and installed to meet your specific requirements. The third component, the sling, is a specially designed fabric accessory that attaches to the lift by means of a carry bar and straps, and holds an individual while the lift, positioning or transfer takes place. Both the track and sling are generally supplied with the lift at the initial time of purchase. Please refer to any user guides supplied with the C1000 lift and reference them while reviewing this manual.

The C1000 is a fixed ceiling lift, that is, it always remains on the lift track. It has the ability to lift an individual up from one location such as bed, move the individual along the track to another location and finally lower the individual into a chair or bath. It is moved along the track in one of two ways. The first is by manually moving the lift along the track with the aid of a caregiver. The second is by having the lift power itself along the track. The functions of lifting up or down, or moving to the left or right, are accomplished by pressing buttons of a pneumatically (air) operated hand control. The hand control is attached to the lift by way of a rubber airline tubing. Due to the design of the lift system, it takes very little effort to press a button to perform the desired motion.

Please refer to figures 1A and 1B to see sample floor plans of an installed lift system. Refer to figures 2A and 2B to familiarize yourself with the components of the C1000 lift. Figures 3A and 3B show the underside view of the lift as it would be seen by an operator.

Components of lift system

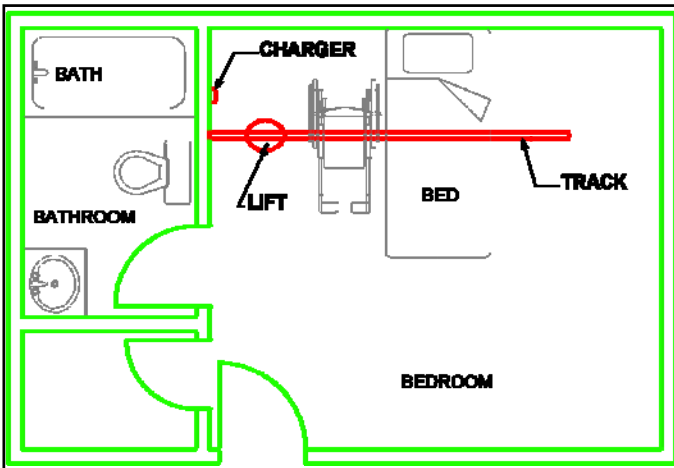

Figure 1A - Sample floor plan showing basic components of a ceiling lift system.

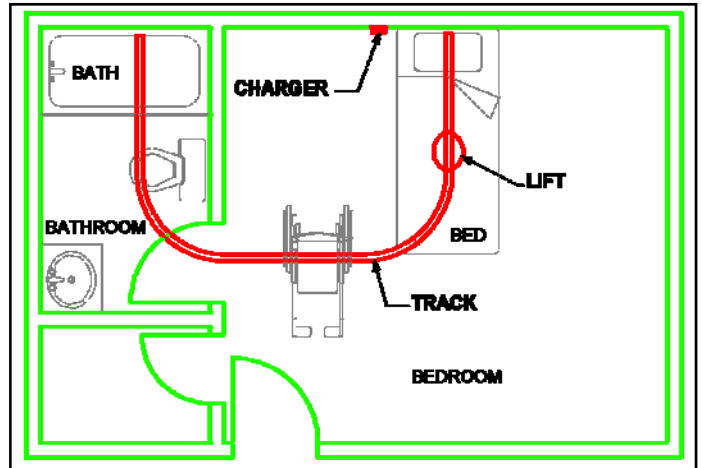

Figure 1B - Alternate sample floor plan showing basic components of a ceiling lift system.

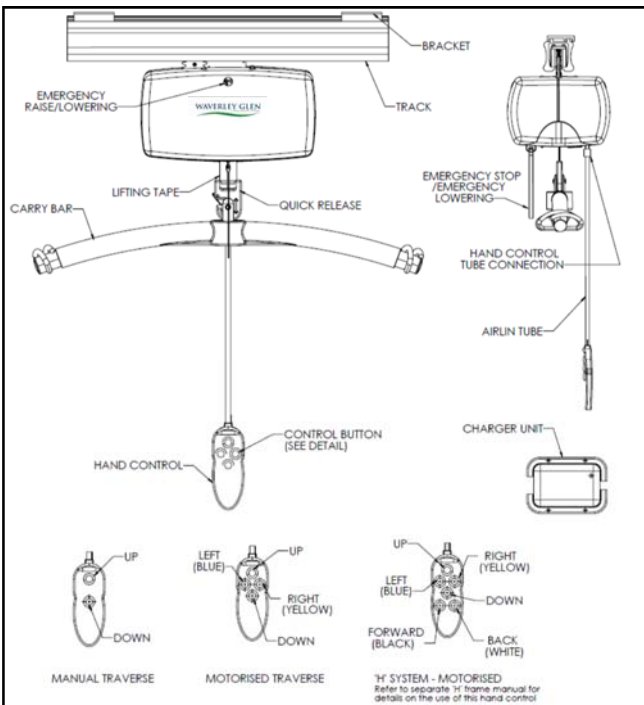

Figure 2A - Basic components of the ceiling lift

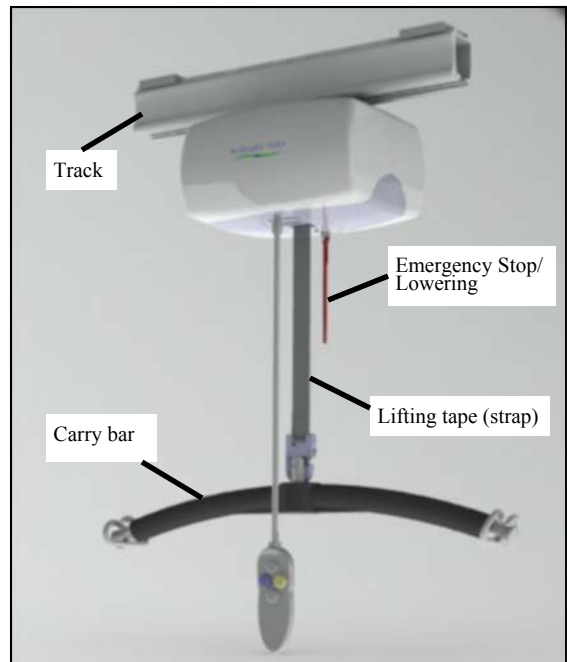

Figure 2B - The C1000 ceiling lift with standard Emergency Stop/ Lowering.

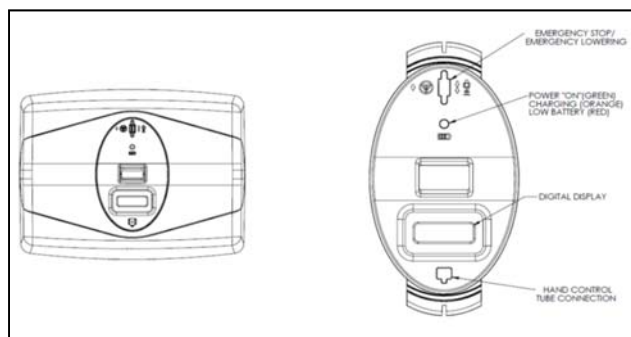

Figure 3A—Underside view of the lift



Figure 3B - Photo of underside

Component List

The following components are included with your new C1000 lift system:

- C1000 lift (Manual or Motorized traverse)
- Pneumatic Hand Control
- Lift Charger (mounted on the wall or ceiling at the end of the track)
- Owner's Manual
- Warranty Card

SLINGS: If a sling has been supplied with the lift refer to the instructions included with the sling.

ACCESSORIES: If additional accessories such as a turntable, or gate system have been supplied with the lift refer to the instructions included with those items.

IMPORTANT: Before initial use, the lift unit must be charged for 4 hours. Refer to section titled "Charging Instructions". The hand control airline tube must also be connected to the lift. If it is not connected refer to the section titled "Connecting airline to the lift".

Specifications of C1000 lift

Shipping/Storage Conditions:

Temperature:	-40 to +70 °C
Relative Humidity:	10 to 100% RH
Atmospheric Pressure:	500 to 1060 hPa

Lift Motor:	24 VDC ===
Traverse Motor:	24 VDC === (Optional at time of Purchase)
"H" Frame Traverse Motor:	24 VDC === (Optional at time of Purchase)
Charger Input:	120VAC ~ 1.0 Amps

Charger Output:	24 VDC === 1.5 Amps
Batteries:	24 VDC === (2 x 12 VDC) 5.0 AH, Sealed Lead Acid
Lift Case:	Flame Retardant ABS
Hand Control:	Pneumatic
Lifting Range:	Up to 96" (2438mm)
Lift Weight:	24.5 lbs.
Maximum Load:	Standard maximum load in 1000 lbs.
Duty Cycle:	1 minute ON, 9 minutes OFF

Maximum load of the installed lift is determined by referring to the product label located on side of lift.

Rated Performance: 17-20 lifts at 1000 lbs, 10% duty cycle, each lift being 24 inches at the middle of the lifting range (from 54" strap out to 30" strap out) per full battery. **Please note:** the lift has a break in period; breaking in of the lift will need to be done before these numbers will be achieved. The breaking in period will vary from lift to lift and is dependent on the frequency of use and the types of load being applied, the higher the load and a greater frequency of use will break in the lift faster.

Service Life: 22, 500 cycles or 10 years, whichever comes earlier
As a precautionary measure, the lifting strap should be replaced every 5000 cycles or 3 years, whichever comes earlier. Higher usage lifts may necessitate more frequent replacement of the lifting strap; please refer to page 26 for General Inspection and Maintenance information.

Type of Applied part: B type



Other Symbols Used:



This symbol is used to point out instructions and information related to work place safety where injury may occur if the information is disregarded or ignored. Follow these instructions, be careful and attentive at all times.



Body Weight



Emergency Stop



Class II Equipment - electrical equipment in which protection against electric shock does not rely on basic insulation only.

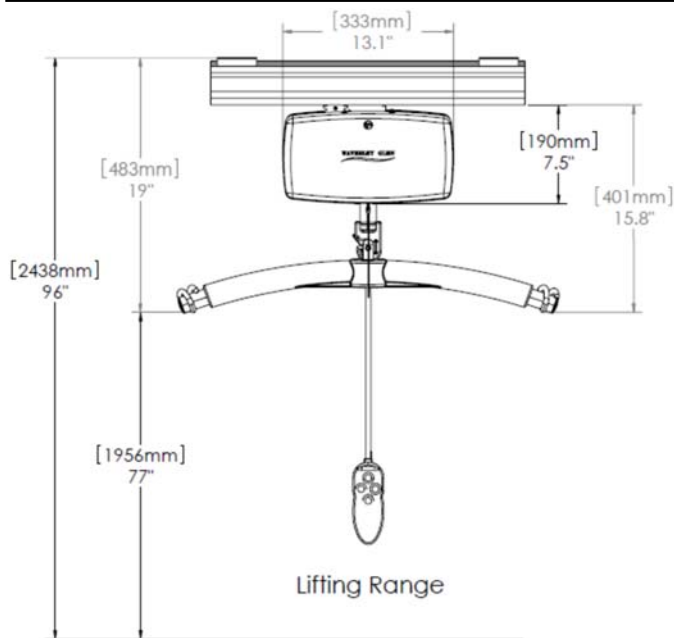

Models Table for C1000 Lift	
Code	Description
329100	C1000 Manual Traverse
329101	C1000 Manual Traverse (Omni)
329102	C1000 Manual Traverse (Rev. G)
329103	C1000 lbs. Manual Traverse (Rev.A)
329126	C1000 Power RTC
329137	C1000 Power XY Traverse
329150	C1000 Power Traverse
329151	C1000 Power Traverse (Omni)
329152	C1000 Power Traverse (Rev. G)
329153	C1000 lbs. Power Traverse (Rev.A)

NOTES:

- Please use the following type of plug for C1000 lifts installed in the UK:

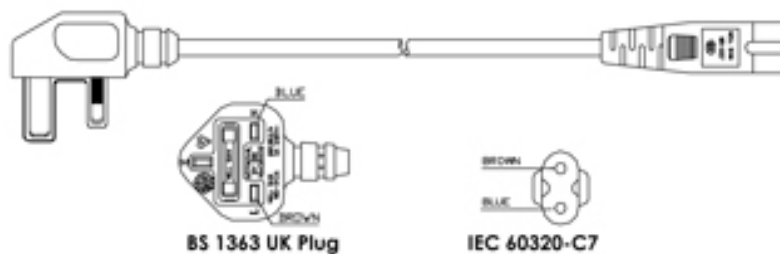

- Please use the following type of plug for C1000 lifts installed in Australia.

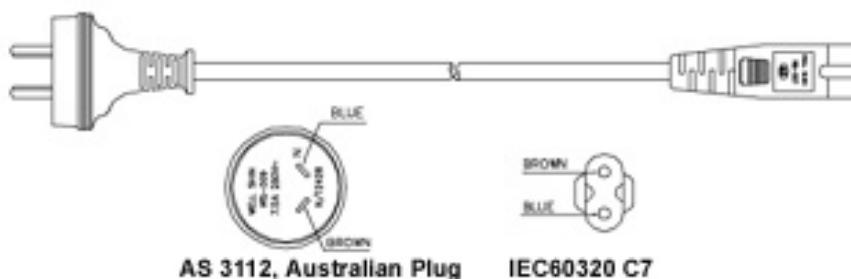

- The C1000 lift shall be connected to a center-tapped single phase supply circuit when users in the United States connect the equipment to a 240 V supply system.

Cautions

- The C1000 must be installed prior to use. Contact your local authorized dealer to ensure that it is properly installed. The C1000 must be installed only by persons authorized by Handicare Ltd.
- Under no circumstance should the C1000 track, lift and sling (s) or entire system be put in control of a person who has not been properly trained in the use and care of this equipment. Failure to adhere to this warning may result in serious injury to the operator, and/or the individual being lifted/transferred.
- The C1000 lift, and associated track and sling (s) are not toys. Do not use it for unsafe practices. Do not allow children to play with the lift or any of its' components.
- The manufacturer's warranty is void if persons unauthorized by Handicare perform work on the C1000 lift system.
- There are no user serviceable parts inside the cover. Do not remove cover screws, or open the lift unit, as this will **VOID THE WARRANTY**.
- In facilities where more than one operator will be responsible for using the C1000 lift and associated track and sling (s) it is imperative that all such members be trained in its' proper use. A training program should be established by the facility to acquaint new operators with this equipment.
- Never expose the C1000 lift directly to water. Warranty does not cover any misuse or abuse of the lift system.
- To maintain optimum function, the C1000 should be inspected and maintained on a regular basis. See the section titled "General Inspection and Maintenance".
- Any accessories used with the C1000 including track and sling (s), should be checked to ensure that they are in good working order. Check for signs of wear or fraying prior to use. Report any unusual wear, or damage immediately to your local authorized Handicare dealer.
- The C1000 lift and associated lift, track and sling (s) are intended **only** for lifting and transferring of a person. Handicare will not be responsible for any damage caused by the misuse, neglect or purposeful destruction of the lift, and/or its' associated components.
- Do not in any circumstance exceed the maximum allowable load of this lift. Refer to the "Specifications" section of this manual, and/or the labels on the side of the lift.
- The installation of the lift, track, accessories, and sling are certified to a maximum load. Do not exceed the maximum rated load of any of the components,
- There is a risk of explosion if the lift is used in the presence of flammable anaesthetics.
- The C1000 has features which improve its electromagnetic immunity but immunity from interference cannot be guaranteed. For best performance keep transmitting devices (cell phones and hand-held radios) away from the lift.
- Ensure that a clear space is maintained around the lift and track. Move all curtain material and other obstacles out of the way before performing a transfer.
- The charger must be located outside the patient vicinity at all times. The patient vicinity is the space with surfaces likely contacted by the patient or an attendant who can touch the patient. This space is 6 feet (1.83m) beyond the perimeter of the bed, examination table, etc., extending vertically 7-1/2 feet (2.29m) above the floor.

Attaching the airline tube to the lift

⚠ Caution: A sturdy ladder may be required in order to access the underside of the lift to re-attach the rubber airline of the lift. Caution should be used when this is required.

Should you have any concerns or questions contact your local authorized Handicare dealer.

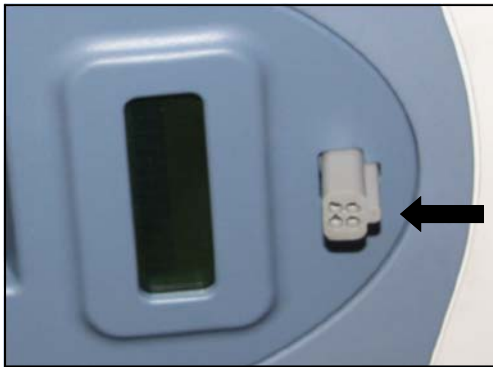
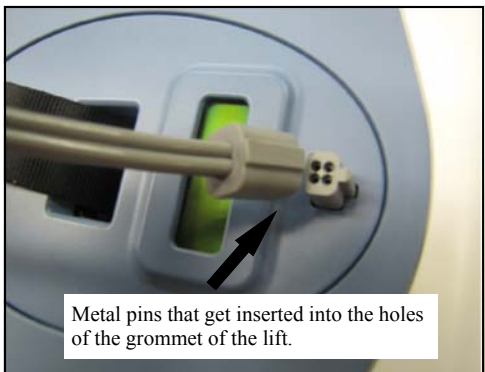
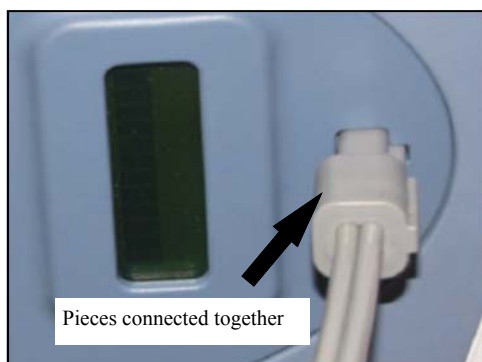

Figure 3A - Gray rubber grommet located on underside of lift. Rubber airline is not connected. Note grey rib on grommet.



Metal pins that get inserted into the holes of the grommet of the lift.

Figure 3B - Gray rubber airline being inserted into rubber grommet of lift. The black ribs on both pieces are lined up. The metal ribbed pins are on the airline.



Pieces connected together

Figure 3C - Gray rubber airline being inserted into rubber grommet of lift. The black ribs on both pieces are lined up. The metal ribbed pins are on the airline.

Should the gray rubber airline that connects the lift to the hand control become disengaged from the underside of the lift it must be re-connected in order for the lift to work properly.

The rubber airline may become disconnected for the following reasons:

- 1) The lift is pulled along the track by the airline.
- 2) The tubing accidentally gets wrapped around an object while a lift or transfer is being performed.
- 3) It is accidentally pulled out by the caregiver or the individual being lifted.

The airline is connected to a gray rubber grommet located on the underside of the lift. Refer to figure 3A.

Small metal ribbed pins located at the end of the airline hold the airline to this rubber grommet in a specific manner. Therefore it is important to make sure that the airline is connected properly.

Both the grey airline and the rubber grommet have a grey rib on one of their sides. Line up the grey ribs together. Refer to figure 3B. When this is done then the metal ribbed pins attached to the end of the airline can be re-inserted into the corresponding holes in the rubber grommet on the underside of the lift. Be sure to insert the pins into the grey rubber grommet sufficiently so that it is secure. Refer to figure 3C.

Perform a brief test to ensure proper connectivity. Turn the lift ON and OFF. Raise and lower the carry bar. For motorized traverse lifts move the lift left and then right. If these functions work correctly then the airline is properly connected.

If the lift does not work properly, check to ensure that the grey ribs on the grey rubber grommet on the underside of the lift and the airline tubing are lined up properly. If they are not lined up properly, then remove the airline, line up the grey lines and then re-insert it into the rubber grommet. Perform the test as noted in the preceding paragraph. If there are still problems with the lift then contact your local authorized dealer for service.

Operation

⚠ Caution: Always, before using the C1000 lift system, the lift, track and sling (s) must be visually checked for any unusual wear, or damage. Refer to the user manual with each piece of supplied equipment to determine what should be checked. Should anything look unusual contact your local Handicare dealer prior to use.

Failure to comply with this caution could result in serious injury to the operator, the individual being lifted and/or damage to the lift.

Turning the lift ON and Automatic OFF

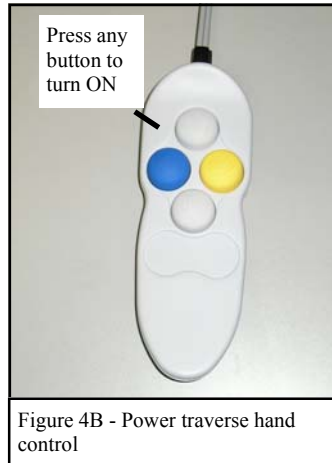
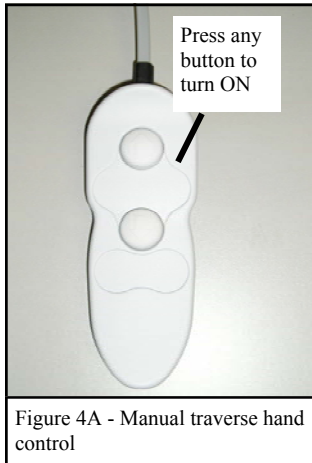

NEW LIFTS OR LIFTS THAT HAVE HAD BATTERIES CHANGED SHOULD BE CHARGED A MINIMUM OF 30 MINUTES BEFORE USE.

Refer to figures 4A, 4B and 4C to determine the hand control that is attached to the lift.

To operate the lift it must first be turned ON with the use of the hand control. This can be done by pressing any button on the hand control. The indicator light located on the underside of the lift will turn GREEN and the display screen will turn on. Refer to Figure 4D. If the lift fails to turn ON at anytime, ensure that the EMERGENCY STOP/ LOWERING CORD has not been pulled and that the plastic clip at the end of the red cord has not come out.

To conserve battery power the lift will automatically shut off after approximately 5 seconds if no buttons are pressed after initial "waking" or after approximately 2 minutes on non-use after last button push.

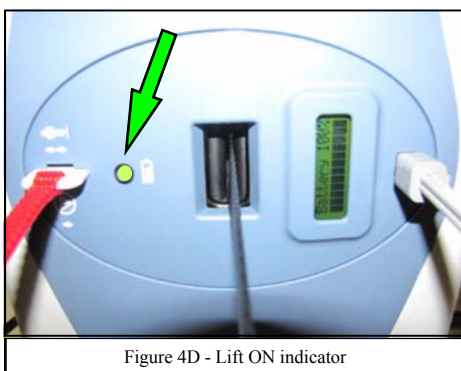

Operation

Raising/lowering the carry bar

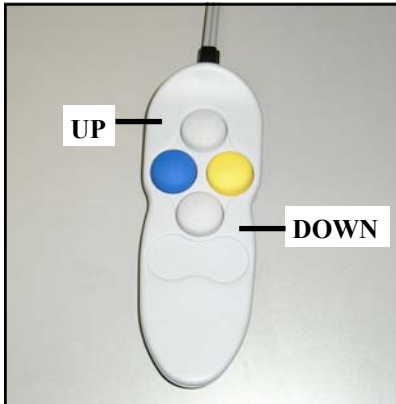

Figure 5A - Power traverse hand control showing raising/lowering func-



Figure 5B - Lift showing raising/lowering of carry bar.

By pressing the DOWN arrow button, or the UP arrow button, the carry bar can be lowered/raised to the correct height for attaching the sling or positioning an individual. Refer to figure 5A and 5B

It is recommended that the caregiver (operator) hold the carry bar with one hand while this is being done so that it will not accidentally sway and/or come into contact with an individual or close object. These buttons work the same on each model of the lift.

Moving the lift

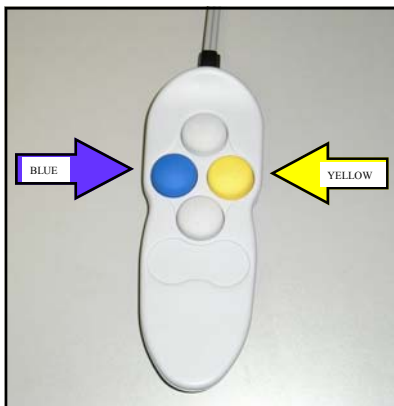

Figure 6A - Motorized traverse hand control showing colored buttons.

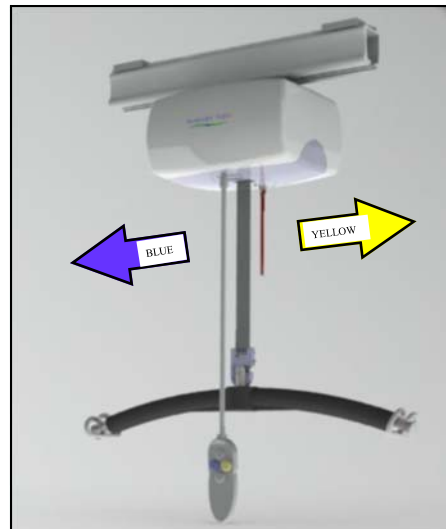

Figure 6B - Lift showing horizontal movement. Arrows are for motorized versions

The lift is normally parked at the charging station end of the track when not in use. It can be moved along the track to a position directly above the person to be lifted in one of two ways.

If you have a **manually traversing** lift lower the carry bar to a comfortable height such that it can be easily grabbed by your hand. Move the lift along the track by gently pushing the carry bar, or individual in the sling. Never pull the lift along the track.



Figure 6C - Directional arrows on underside of lift

If you have a **motorized traversing** lift, use the blue or yellow colored directional hand control buttons to move the lift. The blue and yellow buttons correspond to the blue and yellow directional arrows on the underside of the lift. The direction therefore that is taken is determined by the color of the button that is pressed. This works the same no matter what side of the lift a person is standing on. Refer to figures 6A, 6B and 6C.

⚠ Caution: Always use extreme care when moving the lift along the track. Watch out for and avoid any obstructions that may cause injury to the individual in the sling and/or damage to the lift.

Operation

Moving the “H” system traversing beam

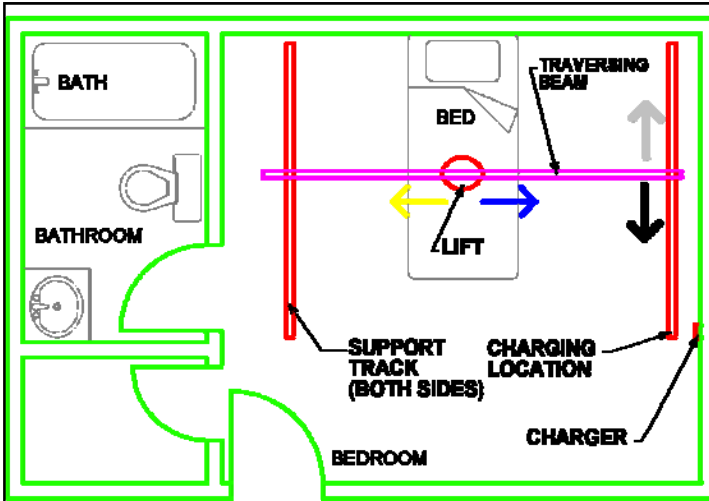

Figure 7A - Sample of “H” system room covering layout. Note that the lift can be moved along the traversing beam, and that the traversing beam itself can be moved along the two parallel support tracks.

The actual direction of travel when the hand control buttons are pressed may be different than shown, since the track and lift orientation may be different than installed. .

If the installed track is an “H” system then this section should be reviewed as it describes how to move the traversing beam. If the installed track is not an “H” system then this section can be skipped.

The “H” system involves the installation of two parallel support tracks and one traversing beam that is mounted perpendicular to the two support tracks. Refer to figure 7A. The benefit of this type of system is that it provides greater movement and positioning ability for an individual since the floor space coverage area is much larger than for a single piece of track.

Besides the previously described UP/DOWN movement of the carry bar, and LEFT/RIGHT movement of the lift, the “H” system adds the ability to move the traversing beam anywhere along the length of the two parallel support tracks. Refer to figure 7A.

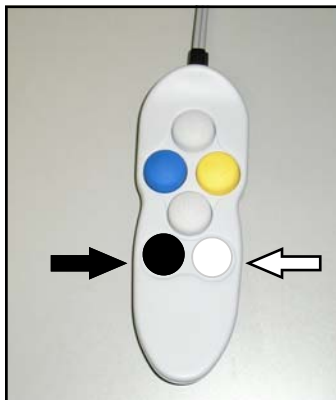

Figure 7B - Power traverse “H” system hand control showing traversing beam movement buttons. Button colors correspond to the black and white directional arrows located on the



Figure 7C - Directional arrows on underside of power traverse “H” system lift. Black and white arrows show traversing beam direction of travel when the corresponding colored button is pressed on the hand control.

figure 7B. This will move the beam in the direction of travel as noted by the black [▼] and white arrows [▲] located on the underside of the lift. Refer to figure 7C.

This can be accomplished in one of two ways. If the installed “H” traversing beam is **manually traversing** then the beam is moved along the support tracks by manually moving the beam, lift, and individual in one motion. This movement is the same as that used for a manual traversing lift, as previously described.

If the installed “H” system traversing beam is **motorized traversing** then the beam is moved along the support tracks by pressing either the black or white hand control button. Refer to

⚠ Caution: Always use extreme care when moving the traversing beam. Watch out for and avoid any obstructions that may cause injury to the individual in the sling, or damage to the lift/track.

Attaching the carry bar to the lift

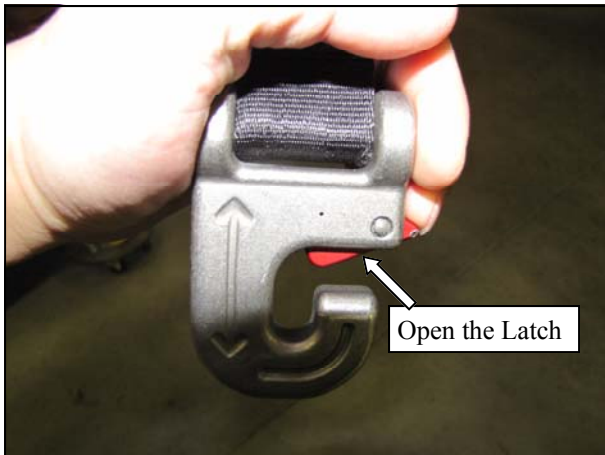

Figure 8A - Open the latch of Quick Release Carabiner

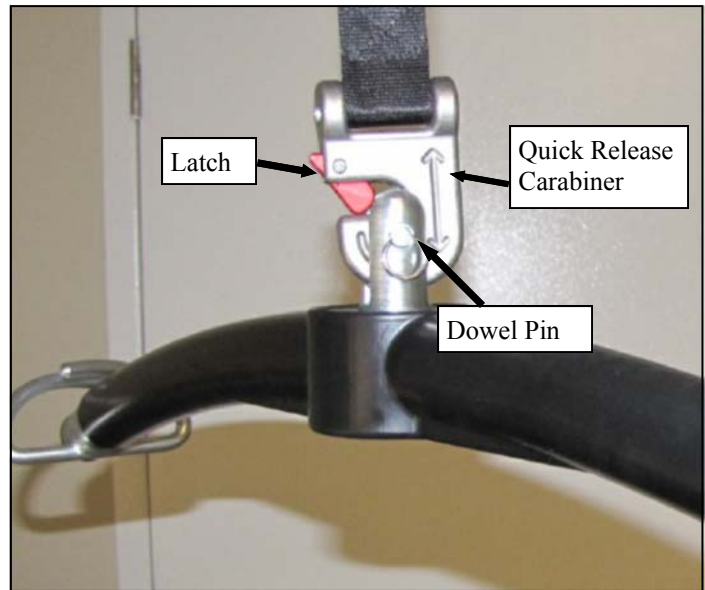

Figure 8B - Insert the Dowel Pin of carry bar into the hook of Quick Release Carabiner



Figure 8C - Attaching the carry bar to the Quick Release Carabiner

Your lift has come with a Quick Release Carabiner on the strap. Open the latch of Quick Release Carabiner by hand. Refer to figure 8A.

Insert the Dowel Pin of carry bar into the hook of Quick Release Carabiner and release the latch. Make sure the latch is closed safely after the Dowel Pin sitting into the hook of Quick Release Carabiner. Refer to figure 8B.

The Carry Bar is attached to the Lift's Quick Release Carabiner. Refer to figure 8C.

Return To Charge (If Equipped)



Figure 8D - Press & Hold the blue and yellow color hand control buttons simultaneously to activate the RTC feature.



If your motorized, traversing lift has a **return-to-charge feature (RTC)**, pressing & holding the blue and yellow colored directional hand control buttons simultaneously for 3-5 seconds (to produce beeping noise) will automatically retract the lift's carry bar and drive the lift along its track until it docks at the charger.

C-1000's is equipped with new **weight sensitive adaptive return-to-charge feature**, which offers added protection during RTC movement. The salient features of new "Load Sensitive RTC" are as under

- 1) If user/operator may have accidentally enabled RTC while a patient is in the lift, the RTC function will stop automatically by sensing excess load on the lift during RTC. The overload threshold is between 40-70 lbs.
- 2) During RTC, if lift carry bar accidentally gets tangled with obstacles, Furniture, drapery etc., the lift will automatically detect the change in the load and if any variation of more than 15-30 Lbs. is detected the lift will stop automatically.

Note:- RTC feature can always be interrupted manually by either pressing any buttons on the hand control or by holding the carry bar firmly.

Note that the RTC feature has several characteristics that may be altered to the user's preference:

RTC Max. Time may be set anywhere from 60 sec to 240 sec in 60 sec increments and represents the maximum time allowed for the lift to travel to and dock at the charger before aborting the operation.

RTC Drop Time may be set anywhere from 3 sec to 24 sec in 3 sec increments and represents the time the lift devotes to lowering the carry bar upon docking at the charger.

RTC Speed may be set to 2, 4, 6 or 8 and represents the relative speed the lift travels at to reach the charger.

Contact your Service Technician to change these settings.

⚠ Caution: Always ensure the carry bar is attached to the lift before activating RTC function. The added weight of the carry bar is required to ensure correct working of limit switches. Failure to have carry bar attached can result in limit switch error, refer to "Troubleshooting" Section at page 25 for recommended solution.

⚠ Caution: Always use extreme care when moving the traversing beam. Watch out for and avoid any obstructions that may cause injury to the individual in the sling, or damage to the lift/track.

Basics in transferring an individual

⚠ Caution: The following steps are intended to generally illustrate the procedure involved in the lifting and transferring of an individual from one location to another using the lift, track and sling. Track configurations will vary by installation.

The manual for the sling that was purchased with the lift should be reviewed in detail prior to attempting these steps, as the sling illustrated here may not be the same as the one that was purchased. Contact your local authorized Handicare dealer if you have any questions or concerns.

Step 1) Move the lift away from the charging station or current location and close to the individual that is to be transferred. Use the procedures for up and down and moving along the track as described in the sections titled, “Raising/lowering the lift” and “Moving the lift along the track”.

⚠ Caution: Always use extreme care when moving the lift along the track. Watch out for and avoid any obstructions that may cause injury to the individual in the sling, or damage to the lift/track.

Step 2) Prepare the individual being transferred with the appropriate sling. Refer to the instructions supplied with the sling that was purchased on how to properly outfit an individual with a sling.

⚠ Caution: Always make sure that the sling is correctly fitted and adjusted on each side of the individual so that maximum comfort and safety are achieved prior to lifting.

Step 3) Once the individual has been outfitted with the sling, move the lift so that it is positioned **directly over the individual**. Lower the carry bar to a height so that the straps of the sling can be easily attached to the carry bar.

⚠ Caution: Always check to ensure that the lift is correctly positioned directly above the person to be lifted. Over time, the lift strap may fray if this is not followed.

⚠ Caution: Check to ensure that the carry bar has no cuts, dents or sharp edges that may come in contact with the straps of the sling and cause damage to them. Report any concerns to your local authorized dealer.

Basics in transferring an individual ... continued

Step 4) Attach the straps of the sling to the hooks of the carry bar. The straps on each side of the sling are generally attached to the corresponding side of the carry bar. Be sure to double check to ensure that the straps are properly attached to the carry bar, and that the individual being lifted is properly positioned in the sling prior to lifting.

⚠ Caution: Prior to lifting an individual make sure that the straps of the sling are securely placed on the hooks of the carry bar and that the straps will not come off.



Sling loop correctly positioned at the base of the carry bar hook.

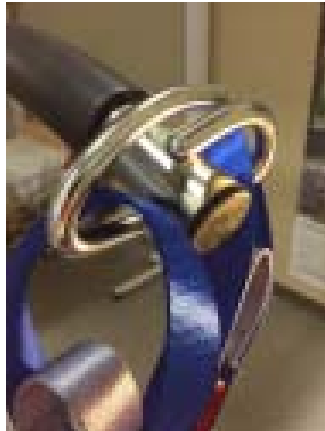

During the preparation for the patient transfer, the tension is reduced.



Sling loop flipped over and incorrectly resting on the hook.



Load applied. The sling loop begins to slide off the hook.

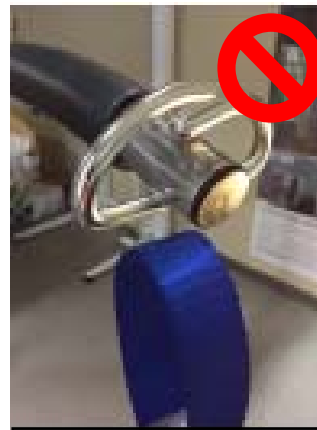

Sling loop separated from the carry bar hook.

⚠ Caution: There is a risk for the strap to disengage from the hook, if a sling loop is allowed to rotate and rest on the top of the hook(s). Please check to ensure that the loops are on the hook not resting in the hook. Failure to adhere to these instructions could result in serious injury or death.

For your safety and the safety of the patient, please always ensure that the sling loops are correctly positioned on the carry bar hooks. It is suggested to do the check of the sling loops once there is tension to the sling loops, but prior to completely lifting the patient.

⚠ Caution: Prior to lifting an individual ensure the hand control cord is free of the carry bar hooks.

Basics in transferring an individual ... continued

Step 5) The individual may now be raised with the use of the UP button on the hand control. While lifting is in progress the height required in order for the transfer to be completed safely should be closely observed. Ensure that the individual being lifted will not be injured by any obstructions during the initial lifting.

⚠ Caution: Always use caution when lowering/raising an individual who is in the sling of the lift. Watch out for and avoid any obstructions that may cause injury to the individual, or damage to the lift.

Step 6) Once at the correct height the individual can be moved along the track to the desired location. Refer to the sections already described in this manual on how to move the lift along the track

Step 7) Once at the desired location the individual in the sling can be lowered/raised to the correct height in order to complete the transfer. On completion of lowering/raising ensure that the individual is properly positioned and safely supported prior to removing the straps of the lift from the carry bar.

⚠ Caution: Prior to removing the straps of the sling from the carry bar be sure to check that the individual being lifted is securely supported in the final desired position.

Step 8) Lower the carry bar sufficiently to allow the straps of the sling to be easily removed from the carry bar. Take care not to let the carry bar come in contact with the individual in the sling. The straps from the sling can now be removed from the carry bar. The carry bar of the lift should then be raised sufficiently and the lift moved away from the immediate area so that it will not interfere with the removal of the sling from the individual.

Step 9) The sling can now be gently removed from the individual. It should then be stored in a safe place for future use.

Step 10) The lift can now be moved to a safe location until further use, or relocated to its' original location. The lift should be turned off when not in use. It is recommended that the lift be left on charge when not in operation. Refer to the section titled, "Charging the lift" for instructions on charging.

Optional Hand Control Hook

Your lift has come with an optional Hand Control Hook. This Hand Control Hook can be installed onto the Hand Control using the self tapping screws provided with the plastic hook. On the back of the Hand Control there will be 2 small pilot holes where the self tapping screws should be screwed into. See figure 9A for a Hand Control with the Plastic Hook already assembled. Figure 9B demonstrates the use of the plastic hook with your lift.



Figure 9A - Hand Control with Hook



Figure 9B - Suggested use

C1000 TANDEM BARIATRIC SYSTEM



In cases where a client's weight, size or medical condition requires precise control when transferring or re-positioning, The C-1000 Tandem Bariatric Lift provides a safe and reliable solution.

The transfer or re-positioning of Bariatric clients can be difficult. A single track can push the legs of a Bariatric client toward the torso, decreasing the hip angle, and compressing the upper body. This can cause discomfort and, in some cases compromise breathing.

Mounted on dual ceiling tracks running parallel to each other, each track fitted with its own independently-operated motor, the C-1000 Tandem Bariatric system allows a caregiver to separately lift torso and legs. This allows the caregiver to keep the angle between the torso and femur open - sometimes difficult to achieve using a single-motor lift system. Precise body positioning, whether seated or recumbent, is possible with the C-1000 Tandem Bariatric System providing maximum flexibility and comfort.

⚠ Caution: The C-1000 Tandem Bariatric system requires more staff co-ordination because of its dual motor system. Each lift has its own hand control and its operated independently often requiring two staff members acting as a team.

C1000 TANDEM BARIATRIC SYSTEM CARRY BAR ACCESSORY



Tandem Bariatric System Carry Bar allows users to take full advantage of dual motor positioning giving greater control of a client's weight between the two (torso and leg) lifting motors. The part number for the Tandem Bariatric Carry Bar is 360765.

Charging the lift

The charger contacts with two metal charging strips that run along the inside of the track. Whenever the lift is over a section of track with charging strips it will automatically start to charge the lift if its battery is low.

 The batteries should be charged on a regular basis. It is recommended that the lift be left on charge when not in operation, and at the end of each day. This will maximize the life cycle of the batteries. The lift may remain connected to the charger indefinitely since the charger has a built-in regulator, eliminating the danger of overcharging.

As a general rule it is recommended that the carry bar be raised to a height so that it will not interfere with anything or anyone while the unit is not in use.

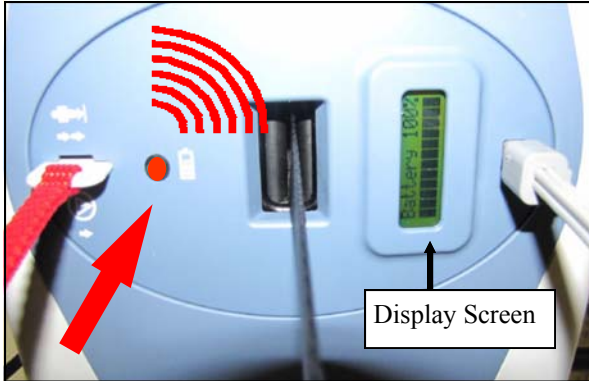

Figure 10A - Underside of lift showing RED discharged battery indicator light and audible alarm beeping every 10 seconds.

The light will turn ORANGE on the lift control panel and a slow beeping audible alarm will sound if the batteries are low and require charging. The display screen will also indicate low battery. Complete the transfer that is in progress and then move lift to the end of the track where the charger is located.

Following the ORANGE indicator, the light will turn RED on the lift control panel and a fast beeping audible alarm will sound indicating the batteries are fully discharged and require charging. The display screen will also indicate low battery. When the battery is discharged the UP function will be disabled. The DOWN and EMERGENCY DOWN function along with X-Y TRAVERSING will continue to operate.

When the lift is on the charger the light on the lift will always be ORANGE. After one hour, the lift may be used, however, overnight charging is recommended. The light will change to GREEN when the lift is removed from the charger. This indicates that the lift is charged between 25%-100%.

⚠ Caution: Use only the Soneil charger that was supplied with the lift or with Mascot 9940 charger. Use of any other charger will void all warranties and may cause damage to the lift.

Allowable Charger Specifications:

-Soneil 2403SRM30, Input: 100-240Vac, 50/60Hz, 1.5A max, Output: +24Vdc, 1.5A

-Mascot 9940, Input : 100-240Vac, 50-60Hz, 0.9amp ; Output: 29.5Vdc, 1.3amp /

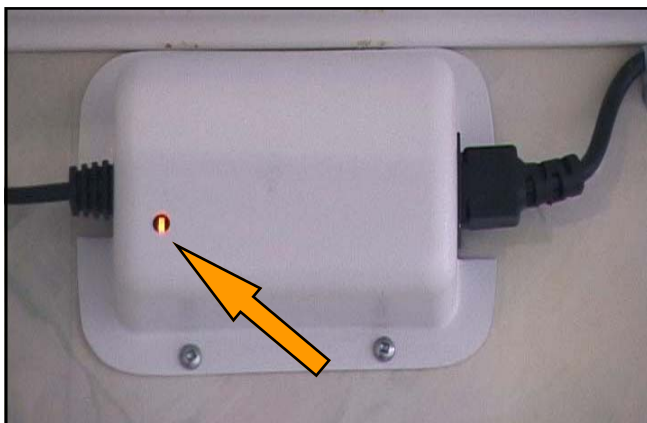

Figure 11A - Charger with ORANGE light indicating that the lift is connected and charging. When the lift is fully charged this light will turn GREEN.

In addition to the indicator lights on the lift, the charger has an indicator light as well. When ORANGE, it indicates that the that the lift is on the charger and charging. Refer to figure 9A.

When the lift is fully charged light on the charger will change to GREEN.

Note: In some circumstances it may be necessary to mount the charger out of view.

Constant Charger

The constant charger system has two metal roller bearings (Figure 11B & C) that contact charging strips that run along the inside of the track. When the lift is over a section of track with charging strips it will automatically start to charge and the light be ORANGE.

Note: Constant charge units don't turn off, since they are constantly connected to the charger.

The Constant Charger can be attached to all operating C-1000 lifts. The batteries can remain connected to the charger indefinitely, since the charger has a built-in regulator, the danger of overcharging is eliminated.



Figure 11B - The Constant Charger attachment to the C-1000 patient lifts.

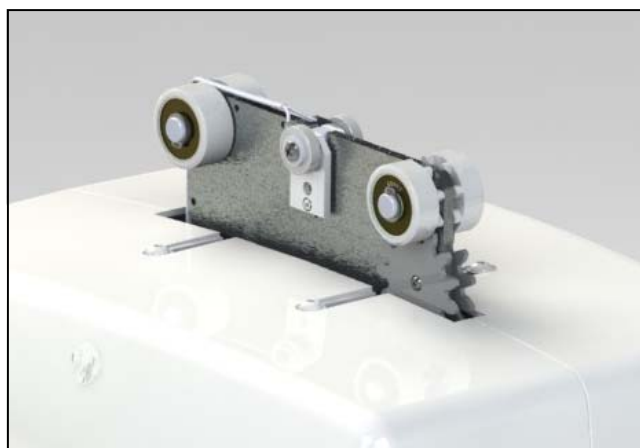

Figure 11C - The Constant Charger attachment to the C-1000 (Rev.G) patient lifts.

LCD Display Functionality

Default Display Modes:

The lift unit can be set to either of the following as the 'Default' display mode:

1. Battery Level (the factory setting for the Default Display Mode); or,
2. Number of Lifts.

To change from one operating mode to another please call your local service technician.

In Battery Level Mode the lift will: (Factory Setting)

1. Display the word, "Battery", with the percentage charged (in 5% increments) in the top row of the display (e.g., "Battery 65%").
2. Display a bar graph of the battery level in the second row of the display by displaying the appropriate number of fully blackened rectangles as in the following diagram:

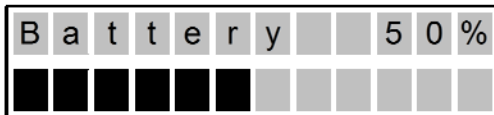

Note: As the lift is initially switched on, the level of battery charge displayed may be incorrect. However, as soon as the lift is actually operated, the charge level will update to the correct level.

In Number of Lifts Mode the lift will:

3. Display the word, "Lifts", with the number of lifts completed in the top row of the display (e.g., "Lifts 500") and a bar graph to indicate the battery level:

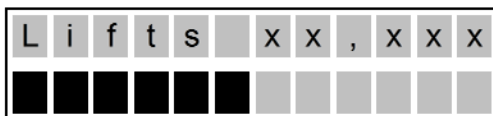

In any 'Default display mode', if the battery levels fall below 25% the lift will go into Low Battery Mode. The lift will then:

1. Change the indicator light on the lift to ORANGE.
2. Make an audible beeping sound every ten (10) seconds.
3. Display will show the battery % in the first line and the charge level bars in the second line.

If the battery are fully depleted the lift will then:

1. Change the indicator light on the lift to RED.
2. Make an audible beeping sound every ten (10) seconds.
3. Display will show "Low Batt!"

LCD Display Functionality

If the unit is in the charger the lift will go into Charging Display Mode regardless what the user has selected as 'Default Display Mode'. Charging Display Mode will over-ride Low Battery Mode.

In Charging Display Mode the lift will:

1. Display "Charger" with the percentage charged (in 5% increments) in the top row of the display (e.g., "Charger 65%").

Preventative Maintenance

Preventative Maintenance (PM) should be completed every six (6) months. The lift will alert you if it hasn't had preventative maintenance at:

1. 1,000 lifts (this would equate to 4-5 lifts a day for 180 days); or, 5 total hours of operation.

When the lift alerts you that PM is recommended, the lift will:

1. Beep every 5 seconds
2. The display will alternate between "Maintenance" & "Lifts ###" in the first line if user selected "Number of Lifts Mode". The display will alternate between "Maintenance" & "Battery %" in the first line if user selected "Battery Level Mode".
3. If battery is below 25%:
 - The indicator light goes to ORANGE and the unit beeps every 5 seconds.
 - The display alternates between "Maintenance" & the Display Mode the user selected (see #2 above).
4. If battery is depleted:
 - The display will FLASH "Low Battery" on the first line.
 - The indicator light will go to RED and the beeping will stop.
5. If unit is fully charged:
 - The unit will go back into Maintenance mode and beep every 5 seconds. (The beeping can be stopped by turning the unit off).

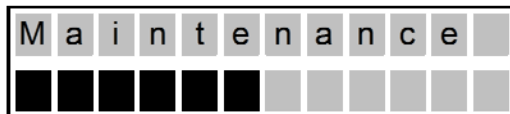

To reset the PM lifts counter:

1. The lift must be in power off state.
2. Press both Up/Down buttons on hand control. The display will indicate "Tech-Prog" and unit will beep.
3. Release both buttons and press the UP button until "Done" appears in the LED display with a beep.
4. PM Lifts counter will be "zero" (0).

Emergency Stopping

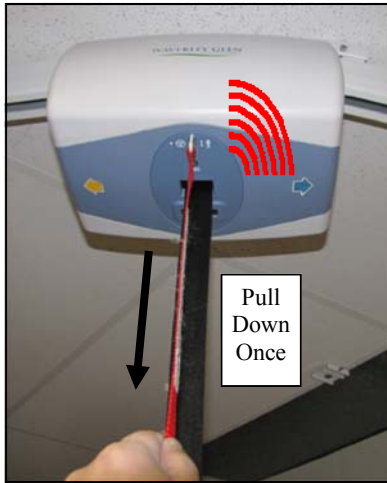

Figure 12A - Pull down on the RED CORD once to stop the lift. The unit will beep once and all power to the lift will be turned off.

The lift unit also has an Emergency Shut-off feature that allows the operator to shut the power to the lift unit completely off. By pulling down once on the RED emergency lowering cord, located on the underside of the lift unit, the lift will immediately stop and all its functions will be disabled. The unit will beep once and all power to the lift will be turned off. The ON Indicator light and display will turn off, and the Emergency Shut-off button located inside the lift case will pop out. Should this feature be used, contact your local authorized dealer immediately. The lift unit must be inspected prior to restoring to use. In order to restore power back to the lift unit, the white plastic tab that popped out when the cord was pulled, can be easily pressed back into the lift case by use of your finger.

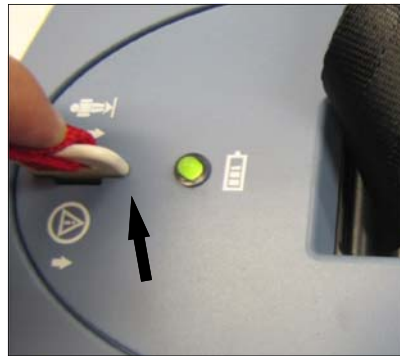

Figure 12B – Return power to the lift unit by pressing in the plastic tab

Once the RED Emergency Stop/Lowering Cord is released the lift unit will need to be reset in order to operate again. This can be achieved by pressing the plastic tab located at the end of the RED CORD, back into the lift unit. Then, simply press any button on the hand control to resume power. Please refer to Figure 12B.

Emergency Lowering

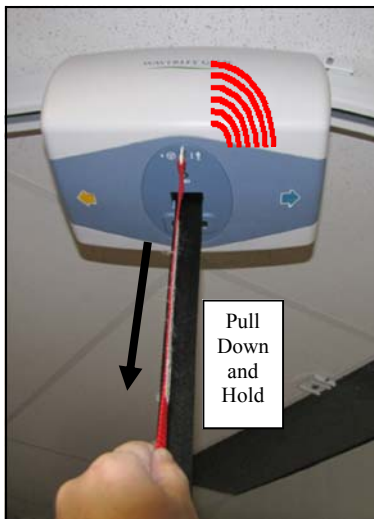

Figure 13A - Pull down and hold until the person is safely lowered to the desired position.

In the event that the DOWN button on the hand control does not function, or in power failure situations, the person may be lowered by pulling down and holding the RED emergency lowering cord located on the underside of the lift unit. Continue to pull down until the person is safely lowered to the desired position. The unit will beep as you continue to pull down on the cord and will continue beeping until the cord is released after the desired lowering has been achieved. Please refer to figure 13A.

IMPORTANT: The Emergency Lowering button does not provide a raising function. The failure of any of the lowering devices should be reported to Handicare or your authorized dealer immediately.

⚠ Caution: In an event of emergency when normal lowering system of the lift malfunctions and the **“Emergency lowering”** function is used, the lift must be reset by a qualified lift technician before re-use. **Contact your local authorized Handicare dealer for service.**

⚠ Caution: When using the **“Emergency lowering”** function the lower limit switch will not engage once the strap spools out the maximum 7ft length. Continued activation will result in reverse spooling and eventually cause extensive damage to the unit.

Emergency Manual Raising or Lowering

⚠ Caution: The manual emergency raising and lowering system should be used only if the lowering procedures described in the previous section of the manual do not work, or, if the emergency raising function is required. Should you have any concerns or questions contact your local authorized Handicare dealer.

⚠ Caution: A proper safety ladder or stool may be required in order to remove the cover of the device. Use extreme caution if this is required. Should you have any concerns or questions contact your local authorized Handicare dealer.

⚠ Caution: **DO NOT use the lift after the manual lowering mechanism has been used.** The lift must be reset by a qualified lift technician after use. **contact your local authorized Handicare dealer.**



Figure 14A– Locate Allen Key supplied with the lift.

Step 1) Locate the Allen key in the plastic bag containing the owners manual, cleviis pin & ring, and hand control.



Figure 14B - Remove clip from side of the lift.

Step 2) Locate a small circular clip on one side of the lift. Refer to Figure 14B. Remove this clip and proceed to Step 3.



Figure 14C - Turn the Allen Key to lift/ lower the lift strap.

Step 3) Insert the Allen key into the hole discovered after removing the clip and turn the key with your fingers. Refer to Figure 14C. Turn the clockwise to lower the lift strap and counter clockwise to raise.

Cleaning and Disinfection

The exterior of the lift should only be cleaned, disinfected using isopropyl alcohol. Damp a cloth with isopropyl alcohol and wipe down entire exterior of lift and hook. No other chemicals and/or liquids should be used to clean, disinfect and sterilize this lift.

 **Caution: Take great care to ensure that no liquids get inside the lift. This lift is not drip proof or water tight. Failure to protect the lift from liquids may result in damage to the lift and/or may cause personal injury.**

The lift strap may be disinfected using Virox Accel TB RTU (Ready-to-use) available from:

Virox Technologies Inc.
1-800-387-7578
www.virox.com

Details of Parts expected to come in contact with patients during Normal use

The following parts and accessories of C-1000 that are intended to contact the patient in normal use.

- Sling (s).

In rare instances contact of these parts are also possible (not deemed as applied parts)

- Carry Bar.
- Hand Control.

Trouble Shooting

Should problems arise with the use of the lift review the following chart. Find the fault and complete the recommended solution. If the fault is not found and/or the solution does not correct the problem contact your local Handicare authorized dealer for service immediately.

Fault	Recommended Solution
The airline tubing that connects the hand control to the lift has become disengaged.	Refer to the section of this manual titled “Attaching the airline tube to the lift”. If this does not correct the problem then contact your local authorized dealer immediately so that the lift can be checked to ensure proper continued operation.
The hand control buttons do not operate according to their designations (e.g. the UP button initiates a traverse movement).	The airline tubing has not been connected correctly. Refer to the section of this manual titled “Attaching the airline and hand control to the lift”. If this does not correct the problem then contact your local authorized dealer immediately so that the lift can be checked to ensure proper continued operation.
The carry bar of the lift does not operate up or down even when the airline has been properly connected.	<p>The indicator light on the control panel located on the underside of the lift should be GREEN. Press the ON button or UP/DOWN arrow buttons or any coloured button on the hand control. This should activate the lift and the indicator light turn GREEN.</p> <p>If the lift still does not function, then the batteries may be low and require charging. Refer to the section of this manual titled “Charging the lift”. Charge the lift for at least one hour and then try to raise/lower the carry bar.</p> <p>If the emergency lowering has been used then the UP and DOWN functions will not operate. DO NOT use the lift. Contact your local authorized dealer immediately so that the lift can be checked to ensure proper continued operation.</p>
The GREEN light on the underside of the lift is ON and the lift does not operate in the DOWN direction.	There is a built-in slack tape detector in the lift. This may be sensitive. Apply weight to the carry bar while pressing the DOWN button. If this corrects the problem temporarily but not permanently then contact your local authorized dealer so that the lift can be checked to ensure proper continued operation.
The red indicator light on the underside lift turns RED and/or a loud alarm sound is heard when an individual is raised.	<p>The batteries are low and require charging. Refer to the section of this manual titled “Charging the lift”. Charge the lift for at least one hour and then try to raise/lower the carry bar.</p> <p>If this does not correct the problem then contact your local authorized dealer immediately so that the lift can be checked to ensure proper continued operation.</p>
One side of the lift tape (strap) is starting to fray after continued use.	Check to be sure that the lift is always directly above the individual being lifted, especially with motorized traversing lifts. Refer to the section titled “Basics in transferring an individual” for correct lift positioning. If fraying still continues then contact your local authorized dealer immediately so that the lift can be checked to ensure proper continued operation.
The lift does not pass through a track component such as a turntable or gate.	Refer to the “Owners Manual” for the specific piece of equipment in question. If the recommended solution does not correct the problem then contact your local authorized dealer immediately so that the lift can be checked to ensure proper continued operation.
No Power.	Ensure the Emergency Lowering tab has not come out. If it has, simply press the tab back into the lift.
Lift not Moving Down after RTC is mistakenly activated without carry bar.	Climb up and pull the strap downwards by holding QRS Hook and press “DOWN” button on hand control, once strap length is convenient re-attach the appropriate carry bar, lift should start functioning normally, if problem persists contact your local authorized dealer immediately so that the lift can be checked to ensure proper continued operation.

General Inspection and Maintenance

A) Each Use - To be completed by User

Prior to each use the C1000 lift and associated track, accessories and sling (s), must be visually inspected. Refer to the accessory and sling user guides for specific details regarding their inspection.

Should any of the these items fail the inspection do not use the lift
Contact your local authorized dealer for service.

Visually check for the following:

- The lift lifting tape shows NO signs of fraying or breaking along its entire length.
- The stitching on the lift lifting tape where it connects to the carry bar shows NO signs of fraying, or breaking.
- The sling (s) that will be used shows NO signs of unusual wear and tear. The straps of the sling that connect to the carry bar of the lift show NO signs of fraying or breaking. Refer to specific sling instructions.
- The carabiner hook shall be visually inspected before and after each lift for damages.
- The airline tube that connects the hand control to the lift is not kinked, twisted, knotted, cut or damaged.
- All the functions on the hand control work correctly (e.g. UP/DOWN/.LEFT/RIGHT, etc..).
- There are not cuts, dents or sharp edges on the carry bar that may damage the straps of the sling.
- The lift has no unusual sounds when the carry bar is moved UP/DOWN or the lift is moved LEFT/RIGHT.
- Ensure that there are end stops installed at each end of the track.

B) Monthly - To be completed by User

Should any of the these items fail the inspection do not use the lift.
Contact your local authorized dealer for service.

- Complete the visual inspection as noted in the “Each Use” section above.

With no one in the sling nor attached to the lift check the following:

- The lift moves freely along the entire length of the track.

C) Semi-Annual or Yearly - To be completed by a lift technician

Generally the recommended Preventive Maintenance interval time is annual. Consult your local authorized dealer for advice on whether Preventive Maintenance should be completed every 6 months or on a yearly basis. Generally, in very frequent use (more than 1500 lifts per year), or in situations where heavier than normal clients regularly are lifted, the lift should be checked every 6 months.



This section to be only completed by a qualified service technician as authorized by Handicare

- Complete the visual inspection as noted in the “Monthly” section above.
- Complete the preventative maintenance procedure as outlined in technical manuals for the C1000 system.**
- C1000 lift checked and passed. Any required repairs completed.

Lift Accessories

The following is a list of available accessories for the C1000 lift. Items such as the track, turntables and brackets are installed at the time of purchase. Add-on pieces are available to after the initial purchase, however your local authorized dealer must be consulted as to suitability, purchase and installation.

Slings are the most common after purchase accessory. A variety of styles, sizes, and colors are available. Custom slings can also be manufactured to meet special needs. Consult your local authorized dealer for details, pricing and a complete list of current sling models.

TRACK
1.82MTR (6FT) AND 2.5MTR (8FT) LENGTHS.
MAY BE CUT AT TIME OF INSTALLATION

TRACK
5.0MTR (16FT) LENGTH
MAY BE CUT AT TIME OF INSTALLATION

TRACKPLUS TRACK
5.0MTR (16FT) AND 8.0MTR (19.5FT) LENGTHS.
MAY BE CUT AT TIME OF INSTALLATION

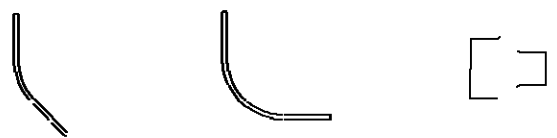

TRACK
45 DEGREE CURVE
MAY BE CUT AT TIME OF INSTALLATION

TRACK
90 DEGREE CURVE
MAY BE CUT AT TIME OF INSTALLATION

TRANSGATE SYSTEM



TRACK END STOP

"H" SYSTEM TROLLEY SET
USED ONLY WITH "H" FRAME
AREA COVERING SYSTEM
(MANUAL OR MOTORIZED)

WALL MOUNT BRACKET

3" TRACK BRACKET

6" CONNECTOR BRACKET

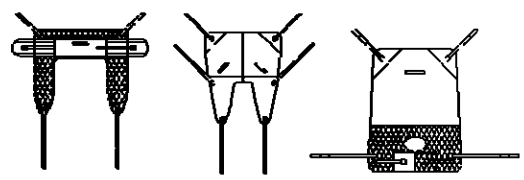

VARIOUS STYLES AND SIZES OF SLINGS.
CUSTOM SLINGS AVAILABLE.

ACCESSORIES NOT TO SCALE.
FOR ILLUSTRATIVE PURPOSES ONLY.

NOTICE: ACCESSORY SIZE, STYLE, SHAPE, LENGTH, CONFIGURATIONS, OPTIONS, COLOURS AND SPECIFICATIONS MAY CHANGE WITHOUT PRIOR WRITTEN NOTICE.

CONTACT YOUR LOCAL AUTHORISED DEALER FOR DETAILS.

 **CAUTION: ONLY SLINGS AUTHORIZED BY HANDICARE ARE TO BE USED WITH THIS LIFT. CONTACT YOUR LOCAL AUTHORIZED DEALER FOR DETAILS.**

Service Record History - Initial Information

- Complete the following section on **Purchase and Service Information** as soon as this equipment is installed.
- Use the service record history to record to any completed service and repairs.
- Ensure that the service record is signed and dated each time it is used.
- Be sure to have this piece of equipment serviced on a regular basis as described in the General Inspection and Maintenance Section.

PURCHASE INFORMATION:

Product Name: C1000 lift **Model:** _____

Serial#: _____

Date of Purchase: _____ **Date Installed:** _____

Purchased From: _____
(local authorized Handicare dealer)

Address: _____

City: _____ **Postal Code:** _____

Telephone No: _____

Comments:

SERVICE INFORMATION:

Contact the following company for service:

Company: _____
(local authorized Handicare dealer)

Address: _____

City: _____ **Postal Code:** _____

Telephone No: _____

Comments:

Service Record History

Complete this section after each service, repair inspection and/or maintenance. Photocopy additional pages as required.

Date: _____		Time: _____	
Service Type: <input type="checkbox"/> Periodic Inspection <input type="checkbox"/> Monthly Inspection <input type="checkbox"/> 6 Month Inspection <input type="checkbox"/> Repair <input type="checkbox"/> Yearly Inspection <input type="checkbox"/> Other: _____			
Completed By: _____		_____	
Printed Name		Signature	
Company: _____			
Remarks & Action Taken:			

Date: _____		Time: _____	
Service Type: <input type="checkbox"/> Periodic Inspection <input type="checkbox"/> Monthly Inspection <input type="checkbox"/> 6 Month Inspection <input type="checkbox"/> Repair <input type="checkbox"/> Yearly Inspection <input type="checkbox"/> Other: _____			
Completed By: _____		_____	
Printed Name		Signature	
Company: _____			
Remarks & Action Taken:			

Date: _____		Time: _____	
Service Type: <input type="checkbox"/> Periodic Inspection <input type="checkbox"/> Monthly Inspection <input type="checkbox"/> 6 Month Inspection <input type="checkbox"/> Repair <input type="checkbox"/> Yearly Inspection <input type="checkbox"/> Other: _____			
Completed By: _____		_____	
Printed Name		Signature	
Company: _____			
Remarks & Action Taken:			

Date: _____		Time: _____	
Service Type: <input type="checkbox"/> Periodic Inspection <input type="checkbox"/> Monthly Inspection <input type="checkbox"/> 6 Month Inspection <input type="checkbox"/> Repair <input type="checkbox"/> Yearly Inspection <input type="checkbox"/> Other: _____			
Completed By: _____		_____	
Printed Name		Signature	
Company: _____			
Remarks & Action Taken:			

Date: _____		Time: _____	
Service Type: <input type="checkbox"/> Periodic Inspection <input type="checkbox"/> Monthly Inspection <input type="checkbox"/> 6 Month Inspection <input type="checkbox"/> Repair <input type="checkbox"/> Yearly Inspection <input type="checkbox"/> Other: _____			
Completed By: _____		_____	
Printed Name		Signature	
Company: _____			
Remarks & Action Taken:			

Date: _____		Time: _____	
Service Type: <input type="checkbox"/> Periodic Inspection <input type="checkbox"/> Monthly Inspection <input type="checkbox"/> 6 Month Inspection <input type="checkbox"/> Repair <input type="checkbox"/> Yearly Inspection <input type="checkbox"/> Other: _____			
Completed By: _____		_____	
Printed Name		Signature	
Company: _____			
Remarks & Action Taken:			

Service Record History

Complete this section after each service, repair inspection and/or maintenance. Photocopy additional pages as required.

Date: _____		Time: _____	
Service Type: <input type="checkbox"/> Periodic Inspection <input type="checkbox"/> Monthly Inspection <input type="checkbox"/> 6 Month Inspection <input type="checkbox"/> Repair <input type="checkbox"/> Yearly Inspection <input type="checkbox"/> Other: _____			
Completed By: _____		_____	
Printed Name		Signature	
Company: _____			
Remarks & Action Taken:			

Date: _____		Time: _____	
Service Type: <input type="checkbox"/> Periodic Inspection <input type="checkbox"/> Monthly Inspection <input type="checkbox"/> 6 Month Inspection <input type="checkbox"/> Repair <input type="checkbox"/> Yearly Inspection <input type="checkbox"/> Other: _____			
Completed By: _____		_____	
Printed Name		Signature	
Company: _____			
Remarks & Action Taken:			

Date: _____		Time: _____	
Service Type: <input type="checkbox"/> Periodic Inspection <input type="checkbox"/> Monthly Inspection <input type="checkbox"/> 6 Month Inspection <input type="checkbox"/> Repair <input type="checkbox"/> Yearly Inspection <input type="checkbox"/> Other: _____			
Completed By: _____		_____	
Printed Name		Signature	
Company: _____			
Remarks & Action Taken:			

Date: _____		Time: _____	
Service Type: <input type="checkbox"/> Periodic Inspection <input type="checkbox"/> Monthly Inspection <input type="checkbox"/> 6 Month Inspection <input type="checkbox"/> Repair <input type="checkbox"/> Yearly Inspection <input type="checkbox"/> Other: _____			
Completed By: _____		_____	
Printed Name		Signature	
Company: _____			
Remarks & Action Taken:			

Date: _____		Time: _____	
Service Type: <input type="checkbox"/> Periodic Inspection <input type="checkbox"/> Monthly Inspection <input type="checkbox"/> 6 Month Inspection <input type="checkbox"/> Repair <input type="checkbox"/> Yearly Inspection <input type="checkbox"/> Other: _____			
Completed By: _____		_____	
Printed Name		Signature	
Company: _____			
Remarks & Action Taken:			

Date: _____		Time: _____	
Service Type: <input type="checkbox"/> Periodic Inspection <input type="checkbox"/> Monthly Inspection <input type="checkbox"/> 6 Month Inspection <input type="checkbox"/> Repair <input type="checkbox"/> Yearly Inspection <input type="checkbox"/> Other: _____			
Completed By: _____		_____	
Printed Name		Signature	
Company: _____			
Remarks & Action Taken:			

Service Record History

Complete this section after each service, repair inspection and/or maintenance. Photocopy additional pages as required.

Date: _____		Time: _____	
Service Type: <input type="checkbox"/> Periodic Inspection <input type="checkbox"/> Monthly Inspection <input type="checkbox"/> 6 Month Inspection <input type="checkbox"/> Repair <input type="checkbox"/> Yearly Inspection <input type="checkbox"/> Other: _____			
Completed By: _____		_____	
Printed Name		Signature	
Company: _____			
Remarks & Action Taken:			

Date: _____		Time: _____	
Service Type: <input type="checkbox"/> Periodic Inspection <input type="checkbox"/> Monthly Inspection <input type="checkbox"/> 6 Month Inspection <input type="checkbox"/> Repair <input type="checkbox"/> Yearly Inspection <input type="checkbox"/> Other: _____			
Completed By: _____		_____	
Printed Name		Signature	
Company: _____			
Remarks & Action Taken:			

Date: _____		Time: _____	
Service Type: <input type="checkbox"/> Periodic Inspection <input type="checkbox"/> Monthly Inspection <input type="checkbox"/> 6 Month Inspection <input type="checkbox"/> Repair <input type="checkbox"/> Yearly Inspection <input type="checkbox"/> Other: _____			
Completed By: _____		_____	
Printed Name		Signature	
Company: _____			
Remarks & Action Taken:			

Date: _____		Time: _____	
Service Type: <input type="checkbox"/> Periodic Inspection <input type="checkbox"/> Monthly Inspection <input type="checkbox"/> 6 Month Inspection <input type="checkbox"/> Repair <input type="checkbox"/> Yearly Inspection <input type="checkbox"/> Other: _____			
Completed By: _____		_____	
Printed Name		Signature	
Company: _____			
Remarks & Action Taken:			

Date: _____		Time: _____	
Service Type: <input type="checkbox"/> Periodic Inspection <input type="checkbox"/> Monthly Inspection <input type="checkbox"/> 6 Month Inspection <input type="checkbox"/> Repair <input type="checkbox"/> Yearly Inspection <input type="checkbox"/> Other: _____			
Completed By: _____		_____	
Printed Name		Signature	
Company: _____			
Remarks & Action Taken:			

Date: _____		Time: _____	
Service Type: <input type="checkbox"/> Periodic Inspection <input type="checkbox"/> Monthly Inspection <input type="checkbox"/> 6 Month Inspection <input type="checkbox"/> Repair <input type="checkbox"/> Yearly Inspection <input type="checkbox"/> Other: _____			
Completed By: _____		_____	
Printed Name		Signature	
Company: _____			
Remarks & Action Taken:			

Warranty

This Warranty does not affect or in any way limit your Statutory Rights.

1. Handicare guarantees all equipment, which includes Ceiling Lifts, Floor Lifts, Slings, Service Parts and Track and accessories, supplied as new, against failure within the period of 1 year from date of installation or 18 months from date of manufacturing, whichever is shorter, by virtue of defects in material or workmanship.
2. Prism guarantees all refurbished equipment supplied against failure within a period of three months from date of installation or six months from date of purchase whichever is shorter.
3. This guarantee does not apply to failure attributable to normal wear and tear, damage by natural forces, user neglect or misuse or to deliberate destruction, or to batteries more than 90 days after original purchase.
4. This guarantee shall be void if the equipment is not serviced by Handicare or its authorized service agents in accordance with the manufacturer's recommendations or if any unauthorized person carries out works on the equipment.
5. The liability of Handicare under the terms of this guarantee shall be limited to the replacement of defective parts and in no event shall Handicare incur liability for any consequential or unforeseeable losses.

If you have any questions about the manufacture or operation
of this equipment, please contact
Handicare, or your local authorized dealer.

Handicare, USA, Inc.
10888 Metro Court
St. Louis, MO 63043 USA
Tel: 314-692-9135
Fax: 314-692-7858
Toll Free: 1-866-276-5438
www.handicare.com

Handicare Canada
485 Millway Avenue, Unit2
Concord, ON L4K 3V4
Tel: 877-304-5438
Fax: 416-260-0256